

View A

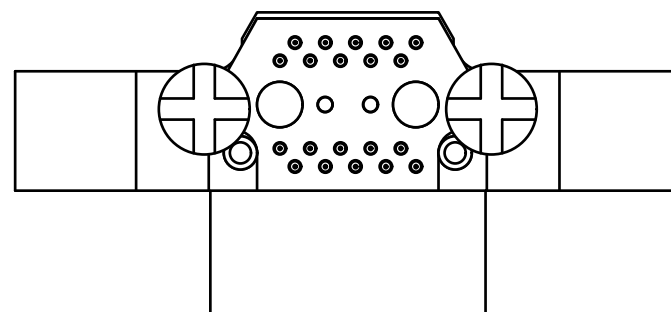

View B

Part No.	SICA20C20Y-GA101
Unit	mm
Design / Date	M.Miura / Jul.01.'08
TET TOKYO ELETECH CORP.	

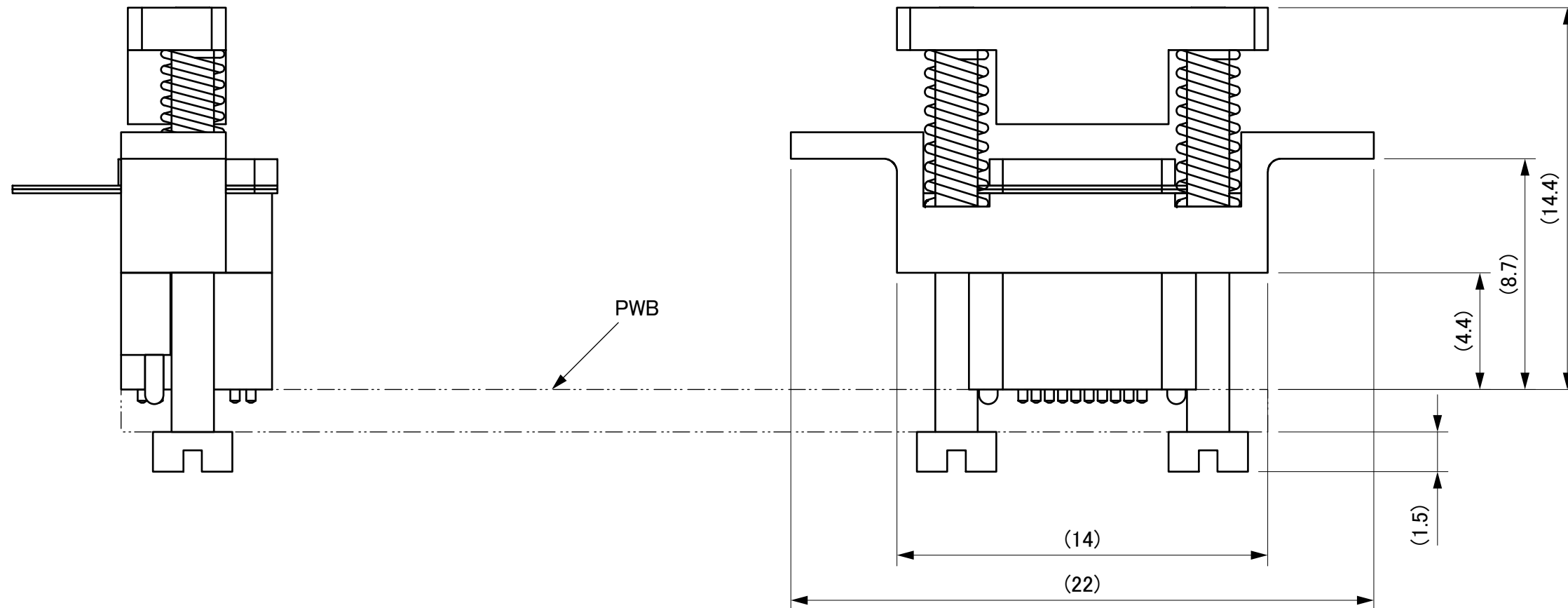

Note)
 1.Applicable PWB thickness
 $t = 1.4 \sim 2.0\text{mm}$

Part No.	SICA20C20Y-GA101
Unit	mm
Design / Date	M.Miura / Jul.01.'08
TET TOKYO ELETECH CORP.	