

8SS

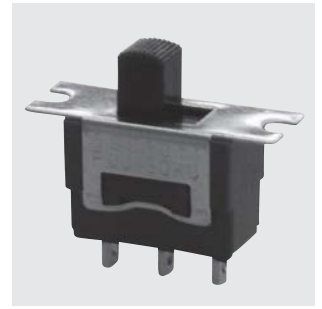

RoHS 指令対応 RoHS Compliant



超小形スライドスイッチ Sub-miniature Slide Switch

仕様

接点仕様	銀接点	金メッキ接点
定格	最大定格 AC125V 6A DC30V 4A 最小定格 AC/DC5V 100mA	DC250V 25mA AC 125V 6A AC/DC20mV 1 μ A
初期接触抵抗	10m Ω Max. (DC2~4V 1A)	20m Ω Max. (AC200 μ V 1.5mA)
初期耐電圧	AC1000V 1分間	
初期絶縁抵抗	1000M Ω 以上 (DC500V)	
電氣的寿命	ON — ON	30,000回
	ON — OFF — ON	20,000回
機械的寿命	100,000回	
使用温度範囲	-30~+85°C	
保存温度範囲	-40~+85°C	

Specifications

Contact specs.	Silver	Gold
Rating	Max.	DC20V 25mA AC125V 6A
	Min.	AC/DC20mV 1 μ A
Initial contact resistance	10m Ω max. (DC2~4V1A)	20m Ω max. (AC200 μ V 1.5mA)
Initial dielectric strength	1,000VAC 1 minute	
Initial insulation resistance	1,000M Ω min. (DC500V)	
Electrical life	ON — ON	30,000 cycles
	ON — OFF — ON	20,000 cycles
Mechanical life	100,000 cycles	
Switch timing	-30~+85°C	
Operating temperature range	-40~+85°C	

形名の説明/Part Numbering

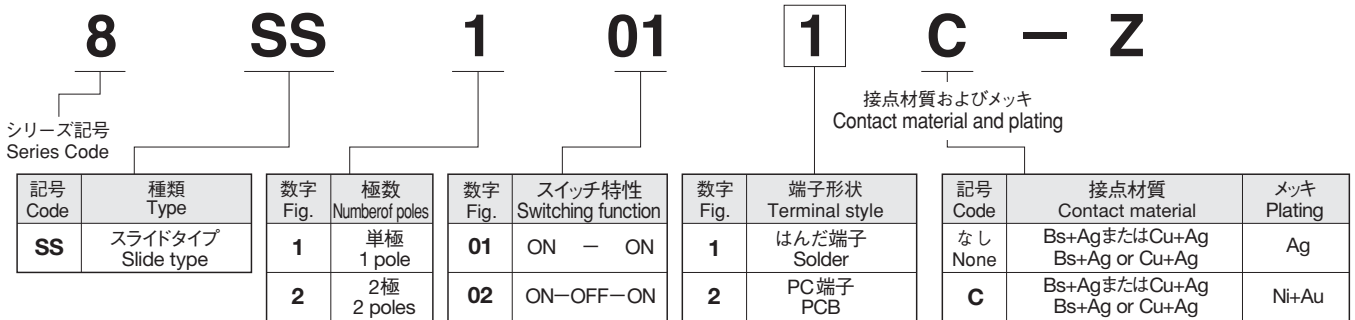

端子形状/Terminal Styles

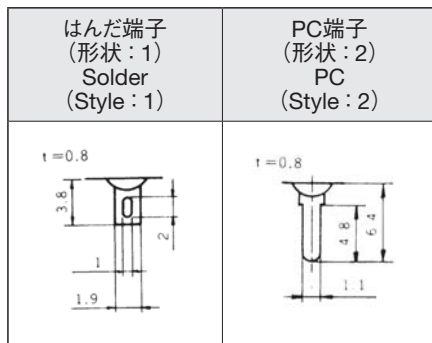

パネル抜孔図/Panel Cut-Out Dimensions

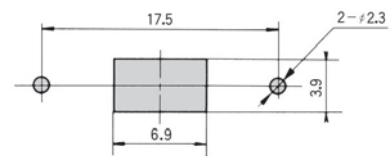

プリント基板孔あけ寸法/PC Hole Layouts

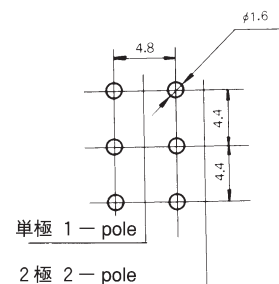

梱包仕様/Packaging Specifications

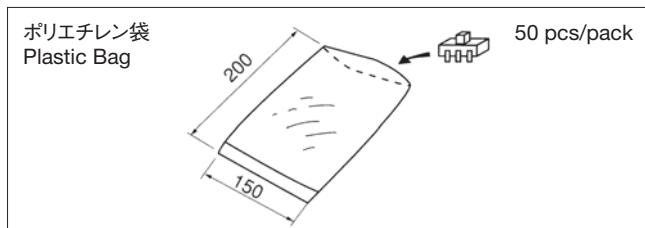

●はんだ付け仕様、洗浄仕様は、415ページエイトシリーズの取扱注意事項をご参照ください。

For soldering specifications and flux cleaning, please refer to the Handling Precautions of the 8 series on P. 415.

単極双投/SPDT

はんだ端子

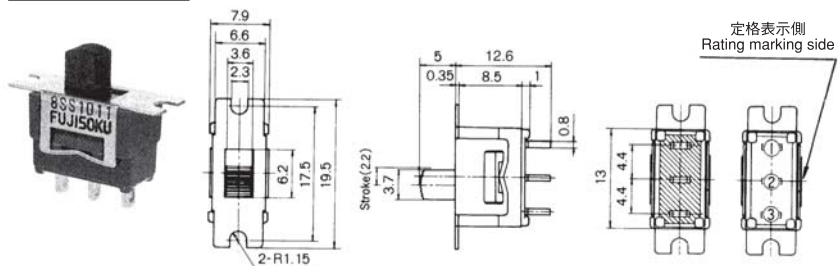

S/D

ボックスには端子番号を表示していません。
The terminal numbers are not shown on the switch.

スイッチ特性 Switching function	定格表示側から見て Viewed from rating marking side		
形名 Part No.			
8SS1011-Z	ON	—	ON
★8SS1011C-Z	ON	—	ON
★8SS1021-Z	ON	OFF	ON
★8SS1021C-Z	ON	OFF	ON
接続端子 Connecting terminals	2-1	—	2-3

■2極双投/DPDT

はんだ端子

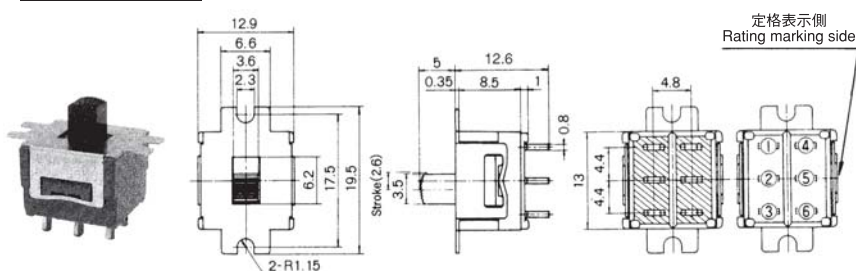

S/D

ボックスには端子番号を表示していません。
The terminal numbers are not shown on the switch.

スイッチ特性 Switching function	定格表示側から見て Viewed from rating marking side		
形名 Part No.			
8SS2011-Z	ON	—	ON
★8SS2011C-Z	ON	—	ON
★8SS2021-Z	ON	OFF	ON
★8SS2021C-Z	ON	OFF	ON
接続端子 Connecting terminals	2-1 5-4	—	2-3 5-6

単極双投/SPDT

はんだ端子

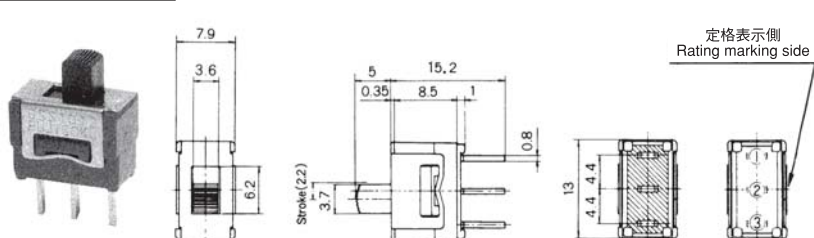

P/C

ボックスには端子番号を表示していません。
The terminal numbers are not shown on the switch.

スイッチ特性 Switching function	定格表示側から見て Viewed from rating marking side		
形名 Part No.			
8SS1012-Z	ON	—	ON
★8SS1012C-Z	ON	—	ON
★8SS1022-Z	ON	OFF	ON
★8SS1022C-Z	ON	OFF	ON
接続端子 Connecting terminals	2-1	—	2-3

■2極双投/DPDT

はんだ端子

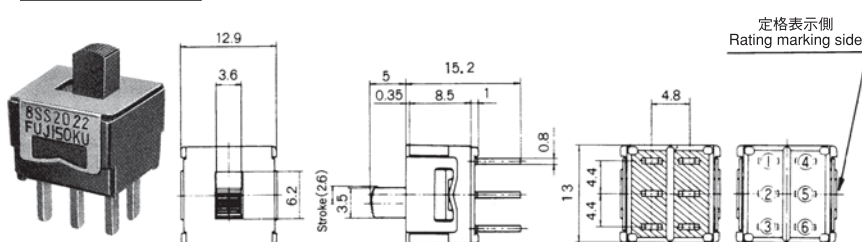

P/C

ボックスには端子番号を表示していません。
The terminal numbers are not shown on the switch.

スイッチ特性 Switching function	定格表示側から見て Viewed from rating marking side		
形名 Part No.			
8SS2012-Z	ON	—	ON
★8SS2012C-Z	ON	—	ON
★8SS2022-Z	ON	OFF	ON
★8SS2022C-Z	ON	OFF	ON
接続端子 Connecting terminals	2-1 5-4	—	2-3 5-6

★(黒星)は、受注生産品です。
★: Made to order products.

UL,CSA認定品一覧表の中で未登録の製品がございます。御注文の際弊社営業に御確認願います。
Not all products are UL-recognized or CSA-certified. Please contact your local Nidec Copal Electronics sales representative.